

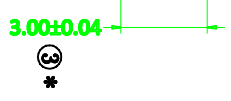

| REVNO | REVISION NOTE | DATE     | DRAW | CHECK |
|-------|---------------|----------|------|-------|
| A/0   | 1.外壳加凸包       | 17/06/20 | 甘伟阳  |       |

NOTE:  
 1. MATERIAL:  
 HOUSING: LCP WITH 30% GF, UL 94V-0, BLACK.  
 CONTACTS: PHOSPHOR BRONZE.  
 SHELL: C2680  
 2. FINISHED  
 CONTACTS: 1U" GOLD PLATED OVER ALL,  
 30U" MIN. NICKEL UNDERPLATING OVER ALL  
 SHIELD: 500" MIN. NICKEL UNDERPLATING OVER ALL

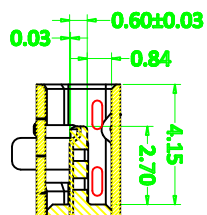
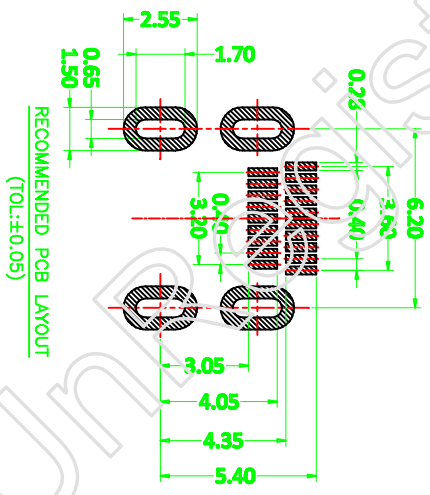
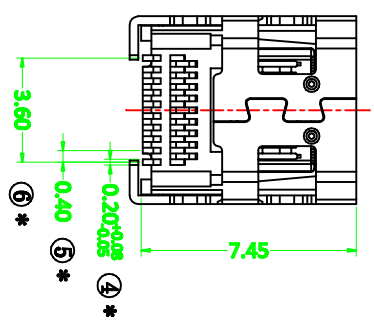
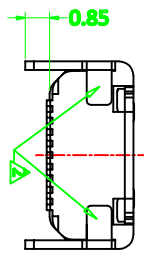
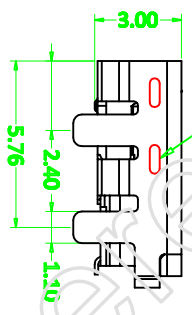
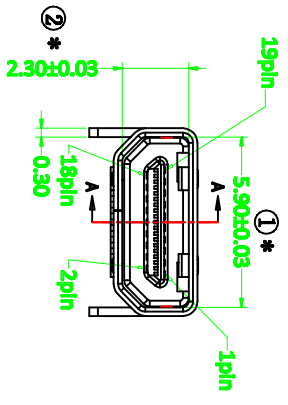
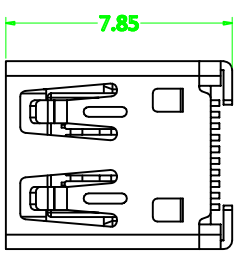

| DIMENSION UNIT MM                    |        | PROD. SPEC. |        | TITLE:<br>HDMI(D-TYPE)B型   |                              |           |            |
|--------------------------------------|--------|-------------|--------|--|------------------------------|-----------|------------|
| TOLERANCE UNLESS OTHERWISE SPECIFIED |        | PKG. SPEC.  |        |  |                              |           |            |
| X&0.25                               | X° 25° | APR.        |        | PRCL.<br> | PART NUMBER: XNT-HDMI-001236 |           |            |
| X&0.15                               | X° 15° | CHK.        |        |  |                              | FILE NO.  | REV.: 8    |
| X&0.10                               | X° 11° | DRA.        | STAVEN |  |                              | SHEET 1/1 | SCALE: 1:1 |

深圳市鑫南天科技有限公司

