

NOTE:

1. MATERIAL:

HOUSING: LCP WITH 30% GF, UL 94V-0, BLACK.

CONTACTS: PHOSPHOR BRONZE.

SHELL: C2680

2. FINISHED

CONTACTS: 1U" GOLD PLATED OVER ALL,
30U" MIN. NICKEL UNDERPLATING OVER ALL
SHIELD: 30U" MIN. NICKEL UNDERPLATING OVER ALL

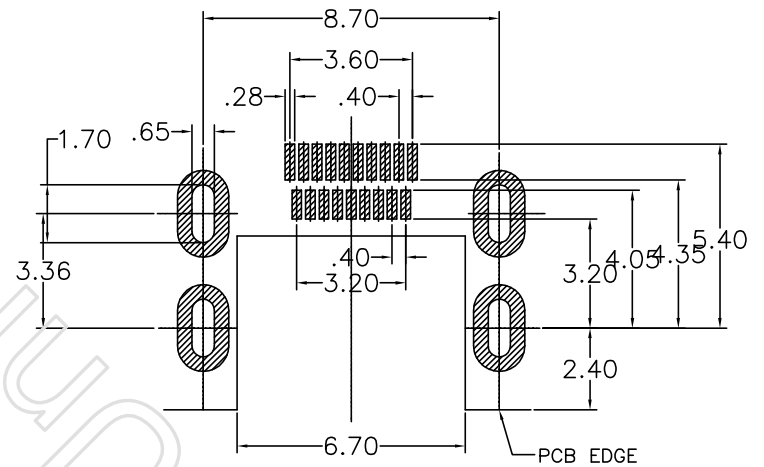
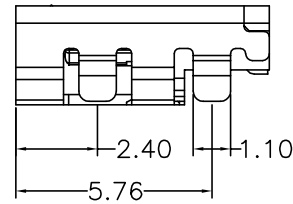
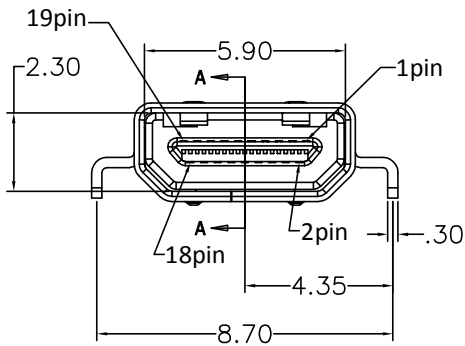
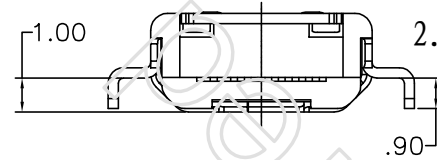
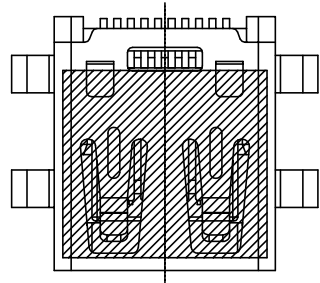

RECOMMENDED PCB LAYOUT
(TOL:±0.05)

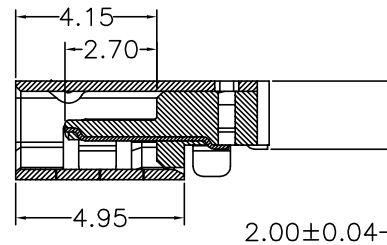
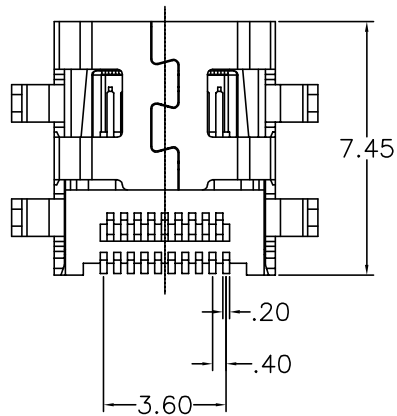

SECTION A-A

XNT		深圳市鑫南天科技有限公司			
.X±0.35	X.*± 5'	APR. co.co	TITLE: HDMI D TYPE 外壳DIP 端子SMT		
.XX±0.25	.X*± 3'	CHK. Ag	P/N XNT07-HDMID19-004		
.XXX±0.15	.XX*± 1'	DRA. Jeff	PROJ. 	DWG NO. XNT-HDMI13082107	SIZE A4
		SCALE 3:1		SHEET 2/3	REV. A